

Professional Bike-Energy-Harvester with integrated Powerbank

The multifunctional Smartphone Supply
for Your Bike

New: USB-C Harvester Version:

- **USB-C Input for Mains Charger**
- **USB-A – USB-C Charging Cable**

Features

- Professional supply for charging and operating your smartphone during biking
- Connected directly to the hub dynamo
- Universal 5V-USB output (USB-A-connector)
- Output current up to 1.5A, buffered by battery
- Overload protection for USB output
- Two independent charging inputs
 - o AC hub dynamo 6V/3W (cable approx. 1m)
 - o USB-Input (USB-C, 5V/2A)
- LED display for
 - o Ready for operation (green)
 - o Ready for operation, 70% discharged (both red and green)
 - o Battery completely discharged (red)
 - o Charging (blue)
 - o Sleep modus (red or green blinking)
 - o Overload (2 x red blinking)
- Rechargeable battery capacitance: 33Wh/3.5Ah, Type LiIon 18650, 3.7V
- Harvester Package: 112 x 62 x 31mm, simple mounting at the bike
- Safe against rain and splash water from 5 sides
- Weight: Harvester: 150gr, mains charger: 50gr

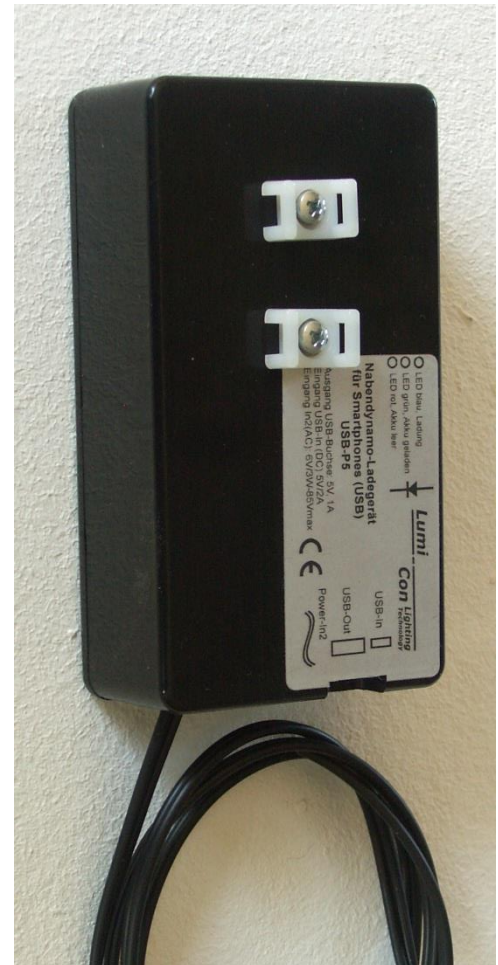

Application

- Professional smartphone supply for bike
- Improved charging from hub dynamo, optimized for speeds between 15 und 35km/h
- 5V charging input from mains (5V mains charger included)
- Simple mounting at the bike

Accessories (attached)

- USB-Cable USB-A – USB-C (Smartphone Interface and Mains Charging Cable)
- Mains battery charger USB 5V
- Mounting material (cable ties), cable to hub dynamo (mounted to package)
- Detailed documentation

Optional Accessories (see in our shop)

- Removable Mounting Set
- Many connectors available for dynamo Interface
- And many more

1. Functional Overview

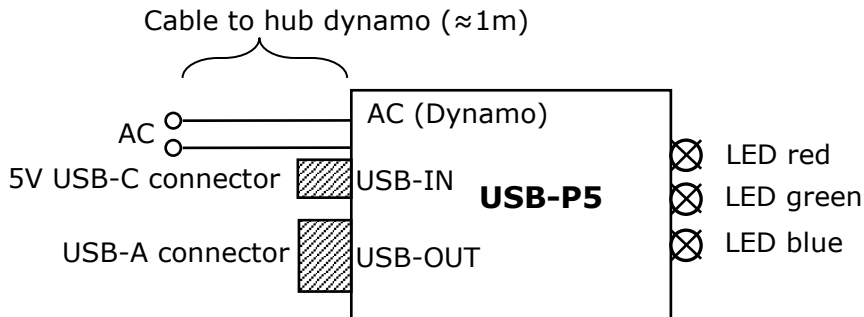

AC: input, connection to hub dynamo, two-core cable, 1m, black, fixed to harvester
 USB-IN: USB-C plug, input 5V, for usage with attached mains charger
 USB-OUT: output, USB-connector type A, 5V / 1.5A max.
 3 LEDs: red (battery empty), green (ready), blue (charging)

Fig. 1: Harvester Interfaces

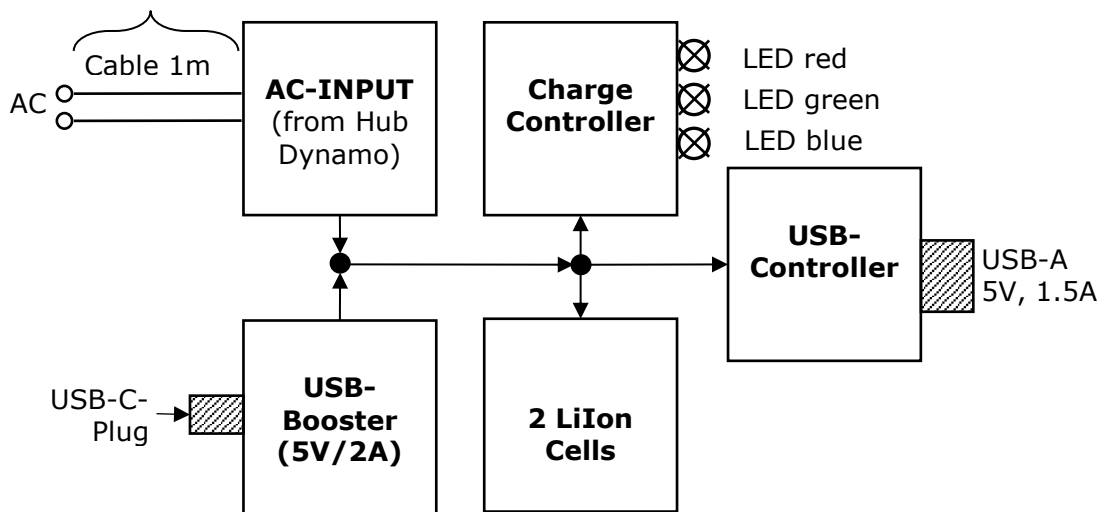

Fig 2: Harvester Functional Diagram

The Harvester incorporates two independent charging inputs. You can connect a typical hub dynamo (6V, 3W, e.g. Shimano) or the attached 5V/2A mains charger. An integrated charge controller guarantees a proper long life operation of the built in LiIon cells (no overcharging or discharging below limits).

The harvester incorporates a very powerful hub dynamo charging-unit (AC) optimized for speeds from 15 to 35km/h (0.8A typically between 18 ... 35km/h). The dynamo input includes a safety circuit to prevent from overload (high voltage during no load). At input currents above 1A the input will switch off.

The harvester may be charged from mains with the attached 5V (DC) mains charger (USB-IN, USB-C plug). The hub dynamo must not operate if charging from mains but may stay connected. This input sinks about 1.5A at 5V. A suitable USB charger is included. Only one of the inputs (AC or DC) can operate at the same time.

The USB controller (USB output) generates a stable output of 5V at a maximum current of 1.5A and has a high efficiency. At overload (>1,6A) the output is switched off.

The user is able to replace the battery cells (LiIon Batteries, Type 18650, flat contacts).

www.lumi-con.de		<h1 style="margin: 0;">Lumi Con</h1>	<p><i>LED-Lighting-Technologies</i></p> <p>Dr. Karl Schrödinger Setheweg 12 D-14089 Berlin</p>	<p>Data Sheet USB-P5-C</p> <p>Bike-Energy-Harvester Professional Bike- Smartphone-Supply</p> <p>Rev. 1.0 – 02/2023</p>

2. Operating Modes

The three LEDs indicate the following operating modes:

a) Sleep Mode: no input or output, testing operating mode every 10 seconds

- 1) Battery empty (voltage < 6V): switch off all functions, red LED flashes every 10 seconds
- 2) Battery not empty (8.4V > voltage > 6V*) no output: switch off all functions, green LED flashes every 10 seconds, output voltage (USB-A) on.
- 3) If input or output current is detected and battery is not empty the Harvester leaves sleep mode.

b) Dynamo Charge Mode: for all battery voltages, testing operating mode every seconds

- 1) Battery empty (voltage < 6V): output voltage (USB-A) off, blue and red LED on
- 2) Battery not empty (8.4V > voltage > 6V*), input current > output current: output voltage on (USB), blue and green LED on
- 3) Battery not empty (8.4V > voltage > 6V*), input current < output current: output voltage on (USB), blue LED flashing and green LED on
- 4) Battery full > 8.4V): output voltage (USB-A) on, charging off, blue LED off and green LED on
- 5) The input switches off at dynamo charge currents above 1A. The blue LED flashes twice briefly.

c) Power Bank Mode: no charge current, testing operating mode every seconds

- 1) Battery not empty (8.4V > voltage > 6V*), no input current, output current on (e, g. Smartphone connected, > 100 mA): output voltage on, green LED on
- 2) as c) 1) output current < 100mA: → sleep mode, a) 2)
- 3) Battery empty (voltage < 6V): → sleep mode, a) 1)

d) Overload Mode, tested every second

At overload (output current > 1.6A) for modes b) or c) the output voltage is disabled: red LED blinks twice. Please remove overload immediately.

*) If battery is discharged by 70% (6.8V > voltage > 6.0V) both red and green LED is switched on.

3. Operating Conditions and Electrical Data

			Min	Typ	Max	Note
Operating temperature	T	°C	0		50	ambient
Humidity	RH	%			90	1
Voltage limiter at dynamo input	V _{AC-PK}	V _{PK}		30		2
Input current from hub dynamo	I _{AC-IN}	A _{eff}		0,8	1	3
Input current at USB-IN (5V)	I _{12V-IN}	A _{eff}		1,4	1,7	4
Output voltage at USB	U _{USB}	V	4,9	5	5,1	5
Output current at USB, V _{USB} = 5V	I _{USB}	A			1,5	6
Mode testing during normal mode	t _{STAT-N}	sec		1		7
Mode testing during sleep mode	t _{STAT-R}	sec		10		8
Time to charge battery at DC input (USB-C)	t _{Lade}	h		1,5		9

Notes:

- 1) Not condensing. Extensively (splashing) water protected from five sides, connector area is open, therefore use vertical mounting, LEDs up, connectors down (connector side is not water protected). Continues operation during rain should be avoided – better use a handle bar bag instead.
- 2) Typical hub dynamo, no load current, light off, hub dynamo with approx. 3W power output
- 3) DC current into battery, see fig. 3, typical hub dynamo, 6V/3W, bike light off, at currents above 1A the input is switched off.
- 4) Use attached battery charger, 5V/DC
- 5) Maximum 1A load current, cable loss not included
- 6) At a load current I_{USB} > 1,6A output is disabled
- 7) Red and/or green LED on
- 8) Red and/or green LED flashing
- 9) USB-C charging time up to approx. 80% battery load level

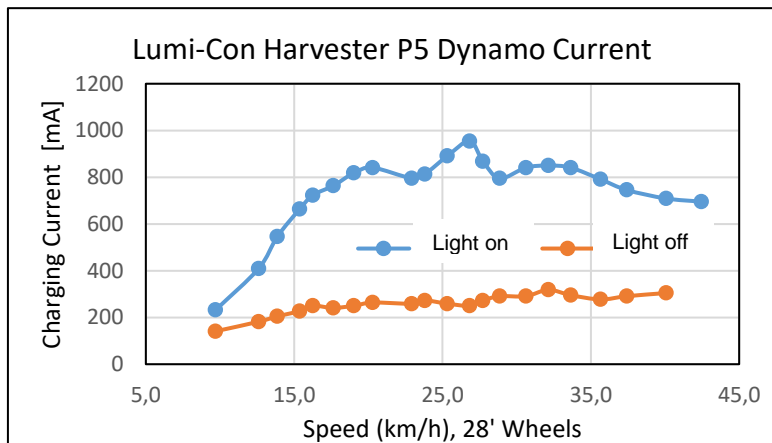

Fig. 3: Charge current and power at a battery voltage of 8V vs. speed, typical hub dynamo (Shimano)



Fig. 4: Supplied Parts: Harvester, mains charger, USB-cable, cable ties, documentation (not on fig.)

4. Dimensions

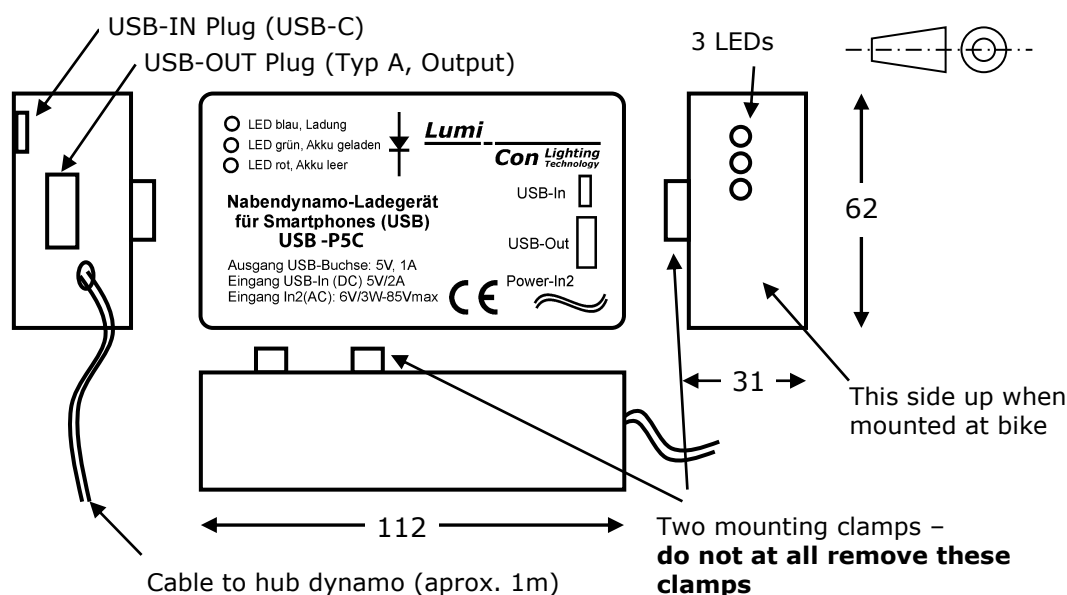

Fig. 5: Dimensions and Interfaces

5. Guarantee

We offer a guarantee for 2 years. Not included are the batteries and if operated outside specifications. (e.g. battery wrongly mounted, operation without battery). A not condensing humidity of 90% means that the harvester cannot be outside in the rain day and night. Permanent (condensing) moisture leads to corrosion of the circuit board. We guarantee function of 5V power input only with attached mains charger.

In case of malfunctions: In the shop (service page) we have listed some tips that you should check first (<https://lumi-con-bike-harvester.eshop.t-online.de/j/service>).

6. Mounting and Operation

Before using first time, open the package and remove the two plastic clips at the battery holder (we recommend using the plastic clips also if the harvester is not in use for longer time). The harvester must directly connected to the hub dynamo in parallel to the bike front lamp. Do not connect to the back light connection. Usually there are several possibilities:

- A) For (mostly used) Shimano only: Clamp the harvester cable together with the light cable in the hub dynamo connector. This is a simple and elegant solution, as no special tools are necessary. See Chapter 7 for details.
- B) Connect the harvester cable somewhere in between the hub dynamo and the front light. You can use any clamps or screw terminals, as well as soldering or using any connector. This solution requires some tooling and is probably not suitable for all users (see example inside USB_D_ZUB.pdf).
- C) We offer mounting of various connectors to help users connecting the harvester.

The harvester needs about 10-12V_{eff} for charging the batteries. If the light is off a typical hub dynamo provides such a level. If the bike lights are on the dynamo reduces voltage level to about 6V_{eff}. In that case the harvester is (nearly) not able to pull current from dynamo. You can however use the power bank function and supply your smartphone.

If the harvester is not used a marginal discharge of the power bank is given (blinking LEDs). A fully loaded power bank would take many months to fully discharge the batteries (self-discharge which could be higher not taken into account). The battery level must no discharge too much. If therefore the red LED is on you should immediately recharge the power bank. The battery is fully loaded if the blue LED is off and mains charger or dynamo is active. The batteries are empty if the red light is on. At a charging level of 30% both red and green light are on.

You can replace batteries in case of defect. We use rechargeable batteries of type LiIon 18650 (3.7V), 2 to 4Ah. Please care for correct polarity when replacing batteries (symbol "+" on printed circuit board and battery holder). Please always replace both cells together.

Do not at all remove the mounting clams at the back (Fig. 5).

You should mount the harvester vertically with LEDs up. Then the harvester is relatively save against water during "normal" rain. Avoid permanent wetness. Alternatively you can use a bike bag or similar for the harvester.

Connecting the Harvester

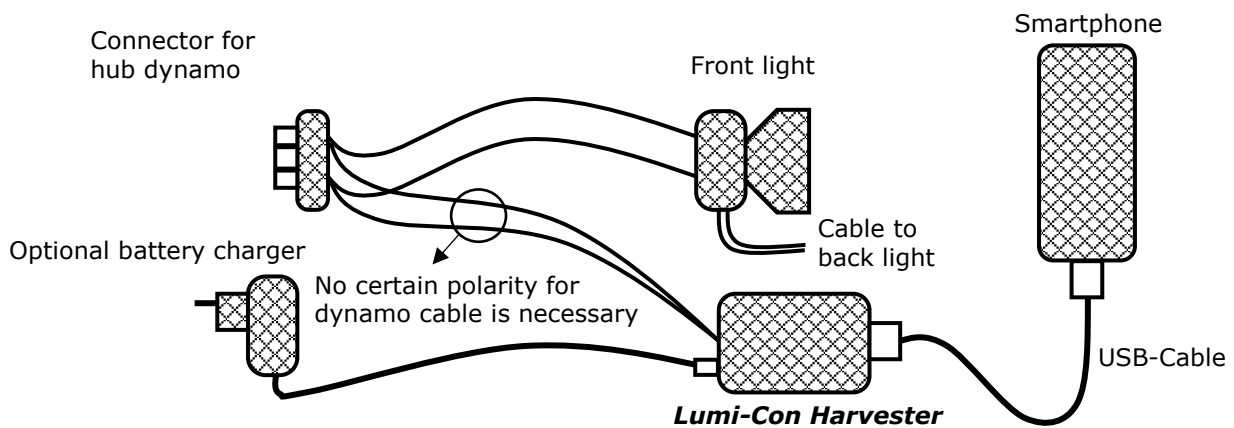
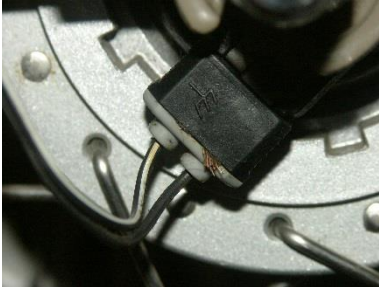
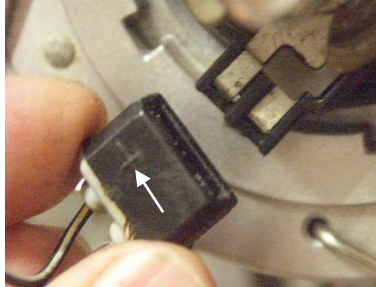

Fig. 6: Connecting the *Lumi-Con-Harvester*

7. Mounting Example with Shimano Connector



1) Look for connector at wheel hub



2) Disconnect and remember the wire which was connected to GND (symbol ⊥**)



3) press flap with suitable tool (e.g. small screwdriver)

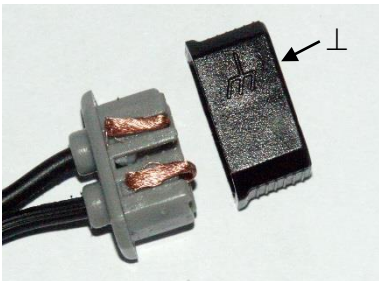

4) Remove connector cap

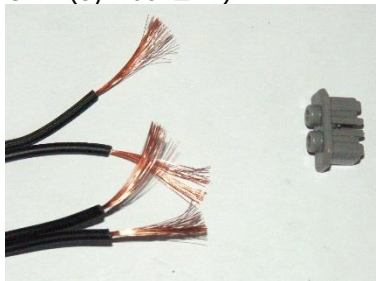

5) Strip isolation for all wires by 20-25mm

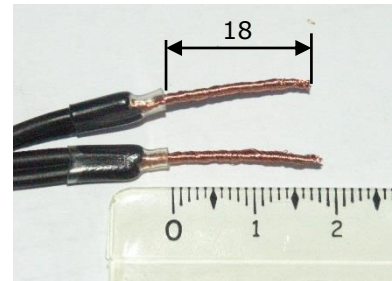

6) Twist wire pairs and cut stripped wires exactly to 18mm

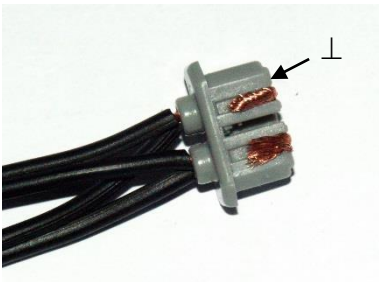

7) Pull in the two wire ends into connector and care for polarity (GND ⊥, see 2)) *



8) Slide on connector cap

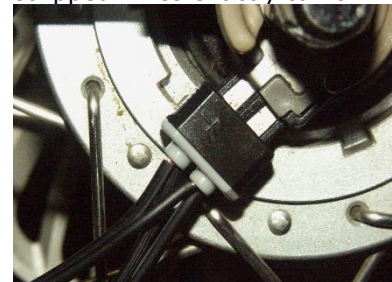

9) Connect again on dynamo and fix cable at the bike frame

*) The stripped wires shall reach the back end of the connector. Please check for shorts due to single thin wires from one cord to the other. No certain polarity for harvester needed – may be the light needs a certain polarity.

***) or similar symbol



Attention please!

The information herein is given to describe certain components and shall not be considered as warranted characteristics.

Terms of delivery and rights to technical change reserved.

We hereby disclaim any and all warranties, including but not limited to warranties of non-infringement, regarding circuits, descriptions and charts.